

**AK(Z) 130/.. - 5,0 (5,08) - grey - BL**

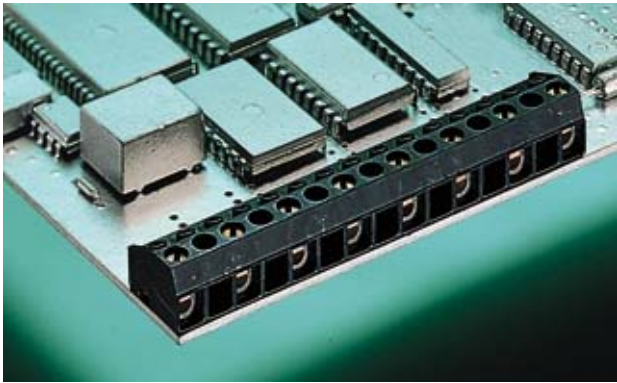

**2-16 poles, Spacing 5,0 mm or 5,08 mm  
insert required no. of poles ..**

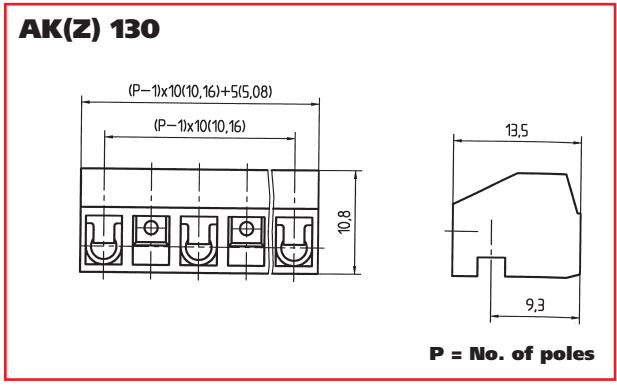

**AK(Z) 130/.. - 10,0 (10,16) - grey - BL**

**2-8 poles, Spacing 10,0 mm or 10,16 mm  
insert required no. of poles ..**

**Ratings:**

			
	UL 1059	CSA 22.2 No. 158	DIN VDE 0627
<b>Rated Voltage</b>	300 V	300 V	250 V
<b>Rated Current</b>	10 A	10 A	10 A (T60)
<b>Wire Size</b>	AWG 22-14	AWG 22-14	1,5 mm <sup>2</sup>
<b>Rating Impulse Voltage/Dirt Level</b>			4 kV/3
<b>Rated Torque / Screw Size</b>			0,4 Nm/M2,6
<b>Max. Rated Cross Section</b>			
Single Wire (solid)			1,5 mm <sup>2</sup>
Stranded Wire (flexible)			1,0 mm <sup>2</sup>
Stranded wire with Ferrules			1,0 mm <sup>2</sup>



**Dimensions**

Spacing	5,0 mm (5,08 mm)
Stripped Length	6,0 mm

**Materials**

Insulating Material	PA
Flammability Class	UL94 V-0
Temperature Range	-30°C/+105°C
Terminal Block	CuZn
Contact	CuBe
Colour	grey
	RAL 7016

**Ratings:**

			 *
	UL 1059	CSA 22.2 No. 158	DIN VDE 0627
<b>Rated Voltage</b>	300 V	300 V	630 V
<b>Rated Current</b>	10 A	10 A	10 A (T60)
<b>Wire Size</b>	AWG 22-14	AWG 22-14	1,5 mm <sup>2</sup>
<b>Rating Impulse Voltage/Dirt Level</b>			8 kV/3
<b>Rated Torque / Screw Size</b>			0,4 Nm/M2,6
<b>Max. Rated Cross Section</b>			
Single Wire (solid)			1,5 mm <sup>2</sup>
Stranded Wire (flexible)			1,0 mm <sup>2</sup>
Stranded wire with Ferrules			1,0 mm <sup>2</sup>

**Dimensions**

Spacing	10,0 mm (10,16 mm)
Stripped Length	6,0 mm

**Materials**

Insulating Material	PA
Flammability Class	UL94 V-0
Temperature Range	-30°C/+105°C
Terminal Block	CuZn
Contact	CuBe
Colour	grey
	RAL 7016